

PLANIMETRIA GENERALE SCALA 1:100

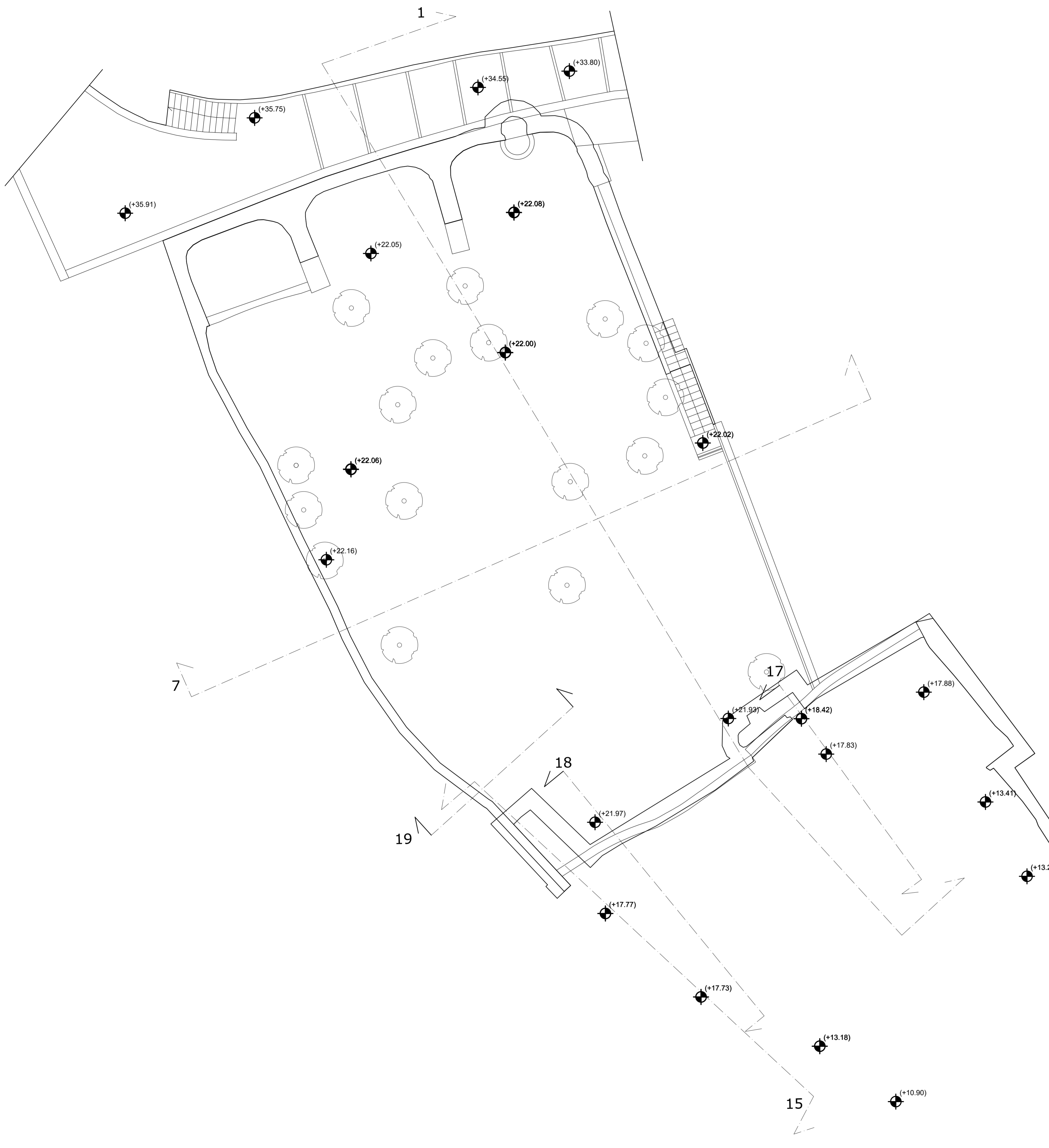

SEZIONE 1 SCALA 1:100

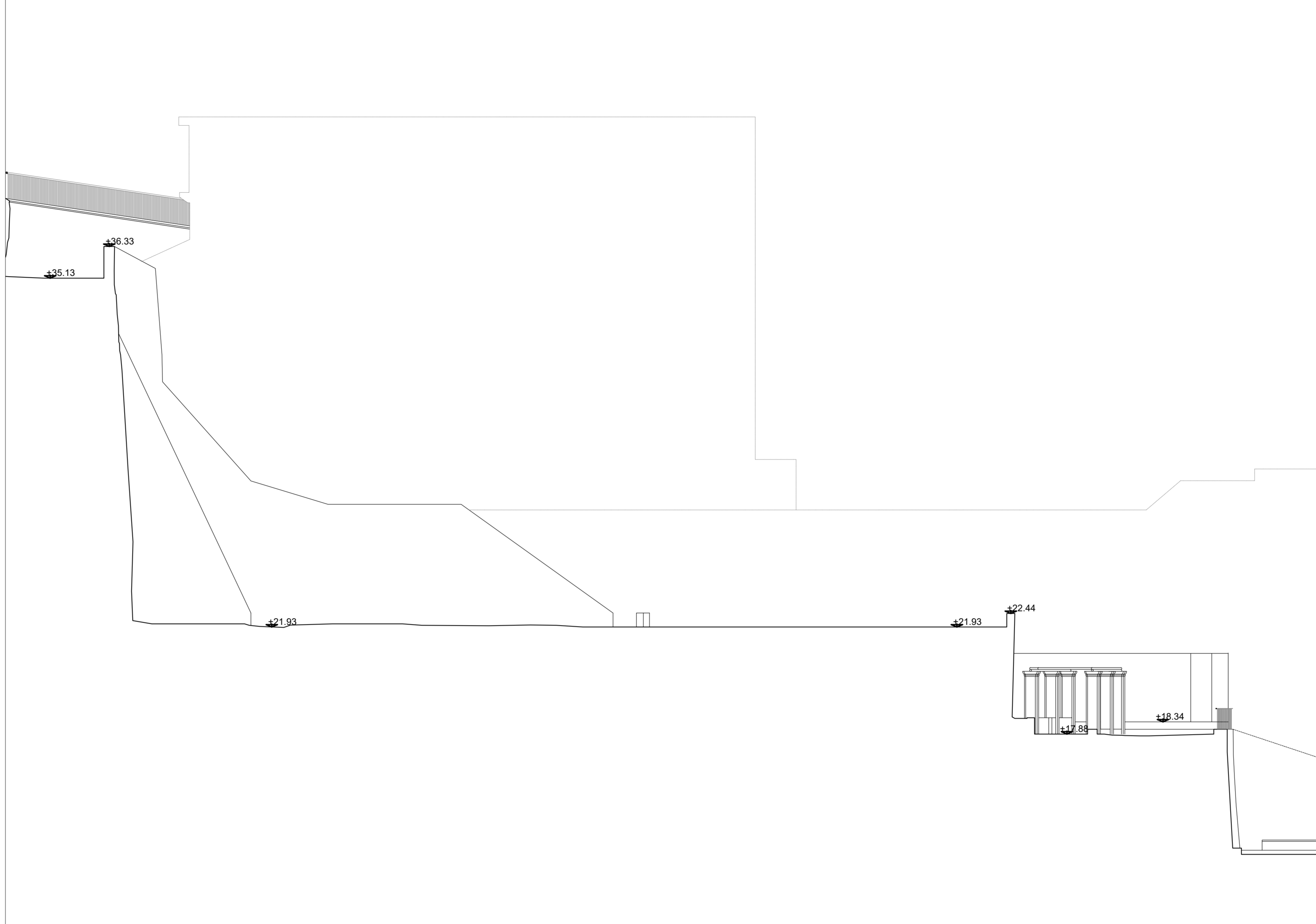

SEZIONE 17 SCALA 1:100

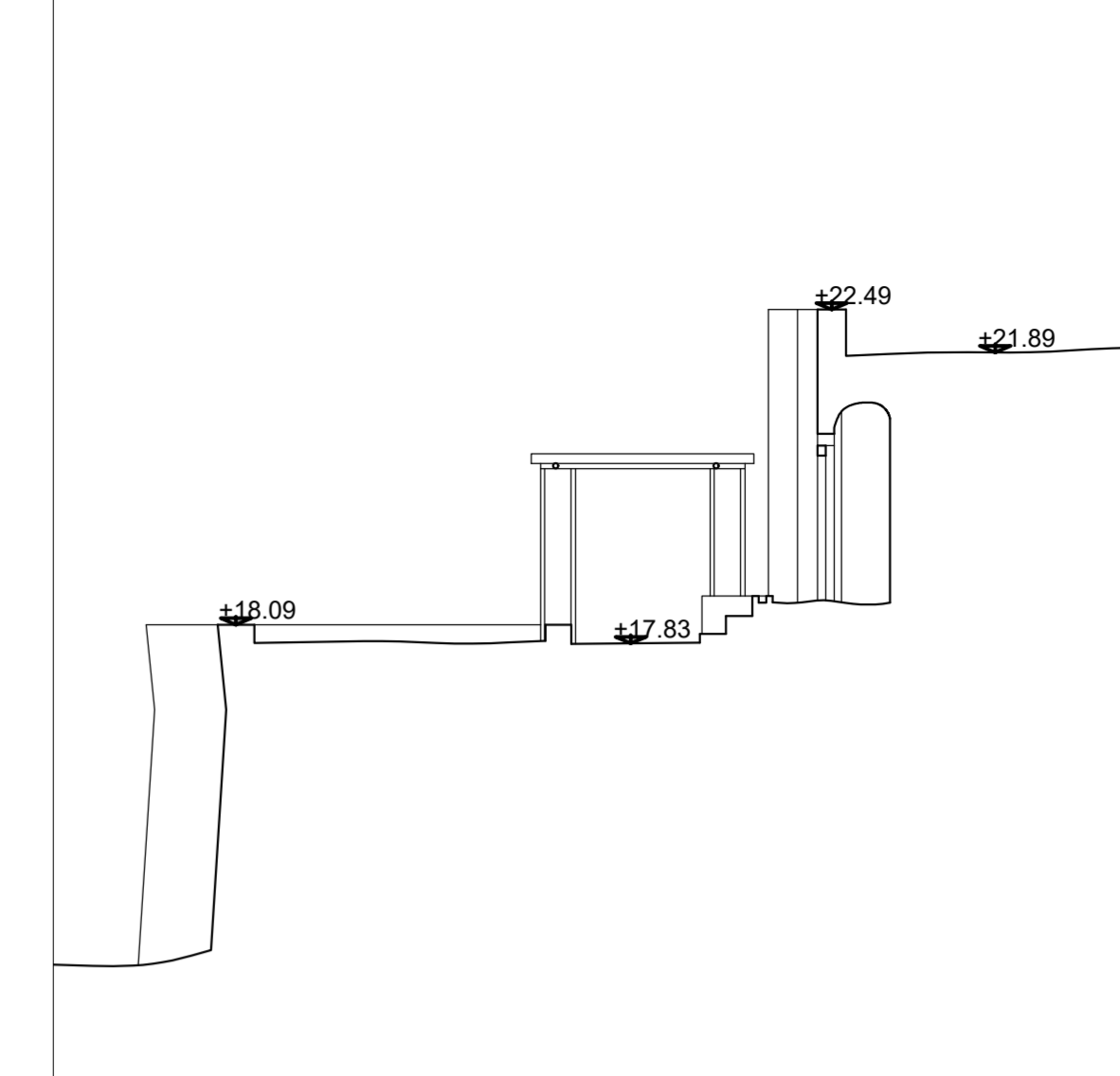

SEZIONE 18 SCALA 1:100

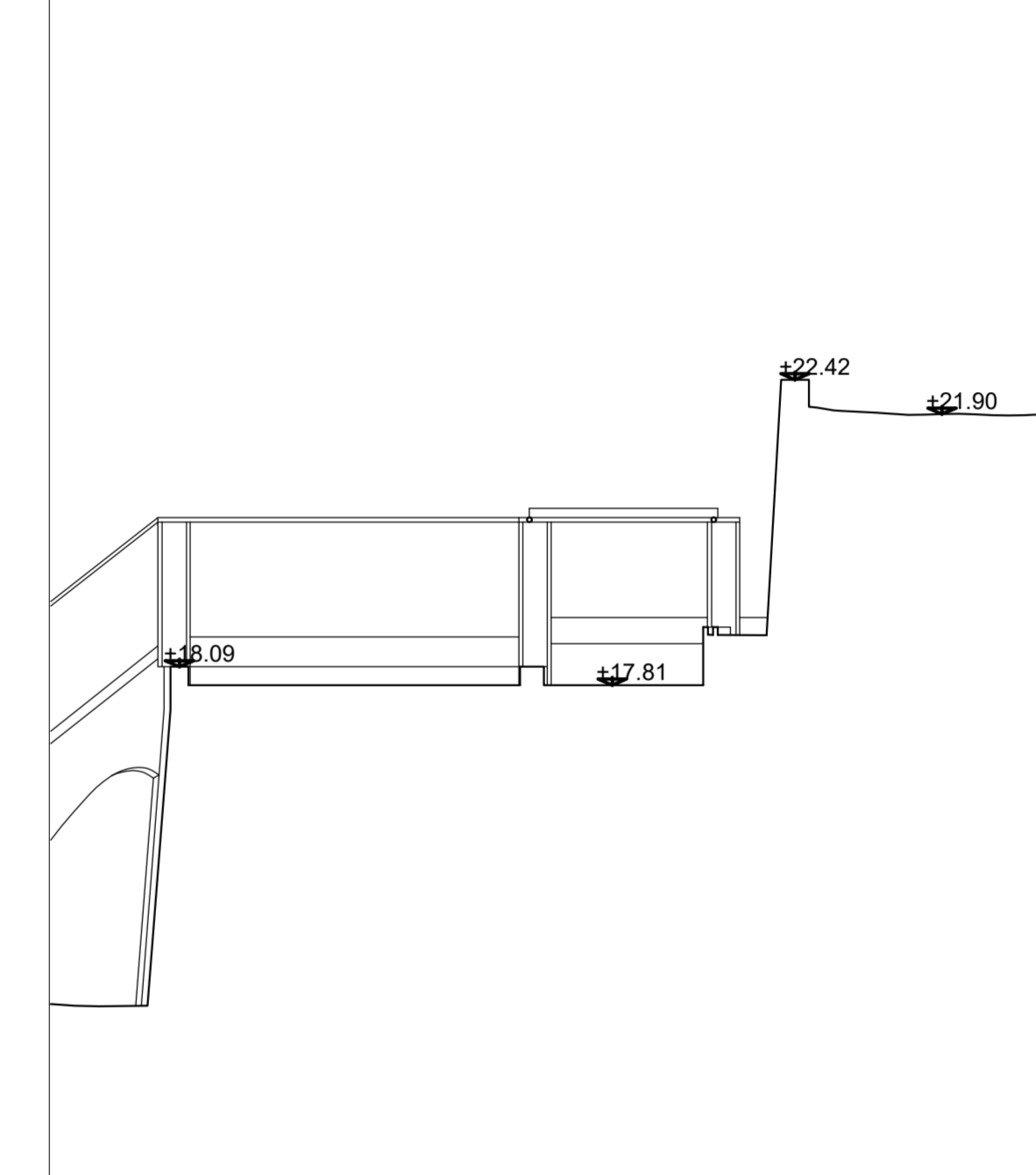

SEZIONE 7 SCALA 1:100

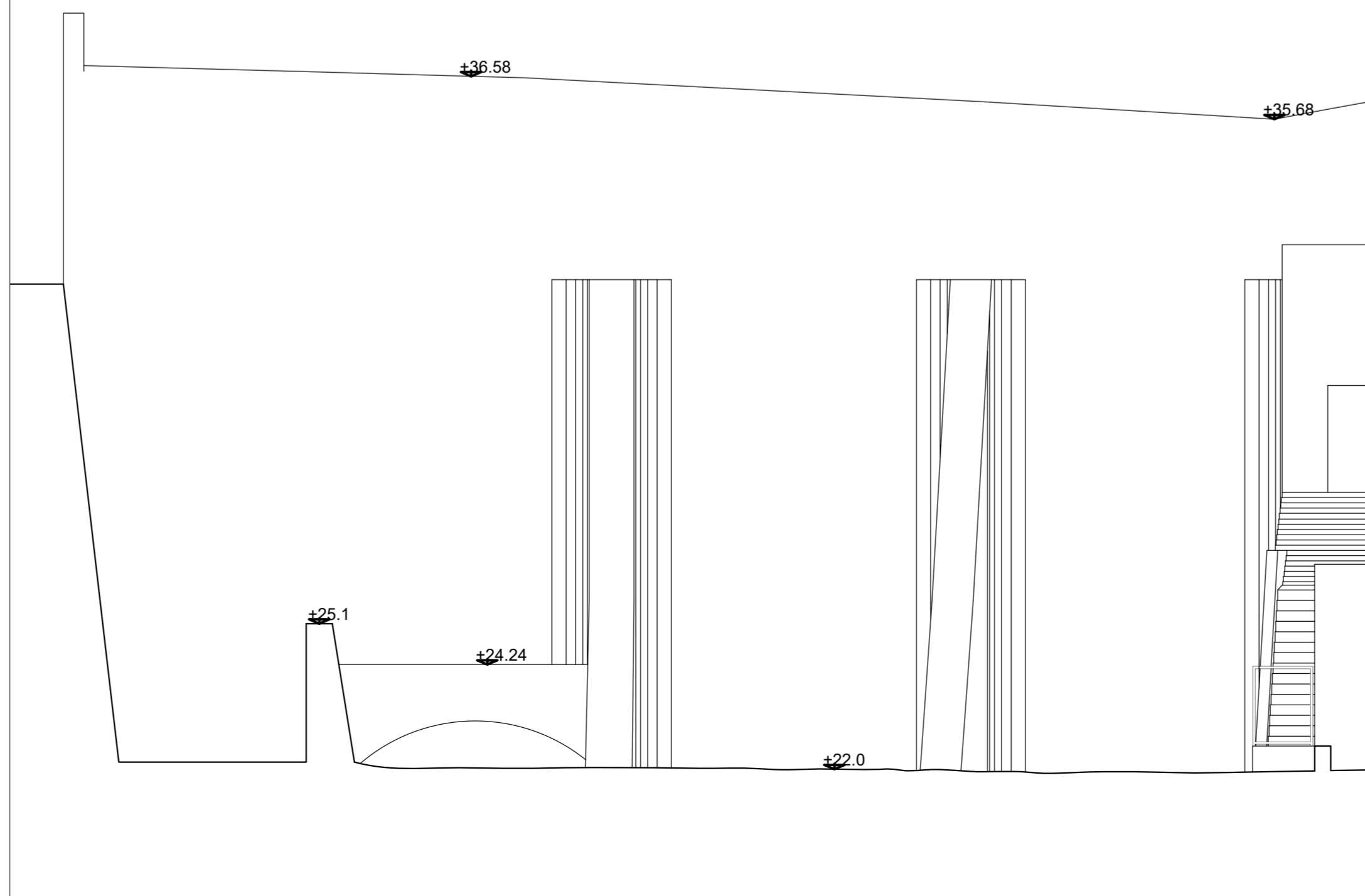

SEZIONE 15 SCALA 1:100

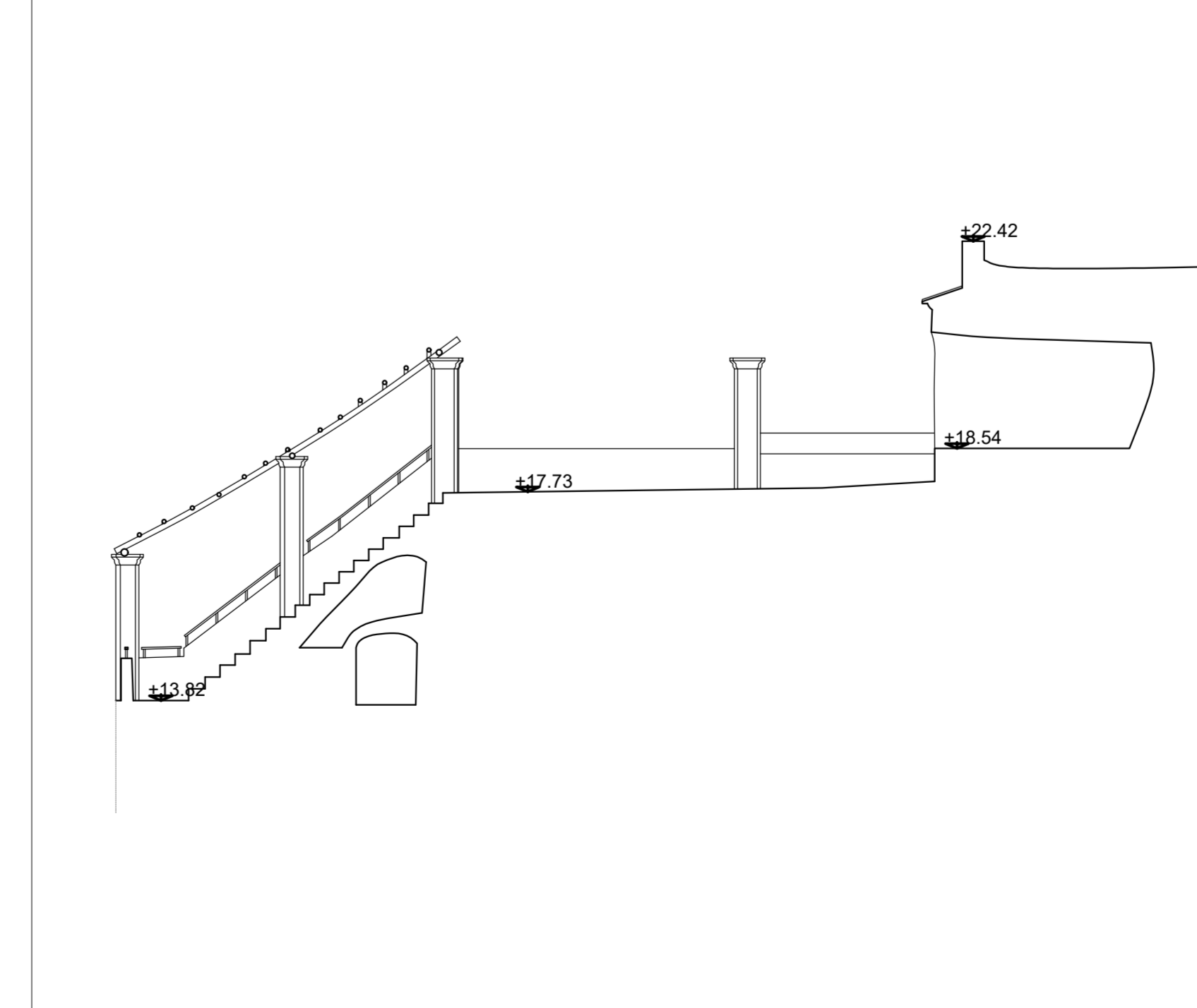

SEZIONE 19 SCALA 1:100

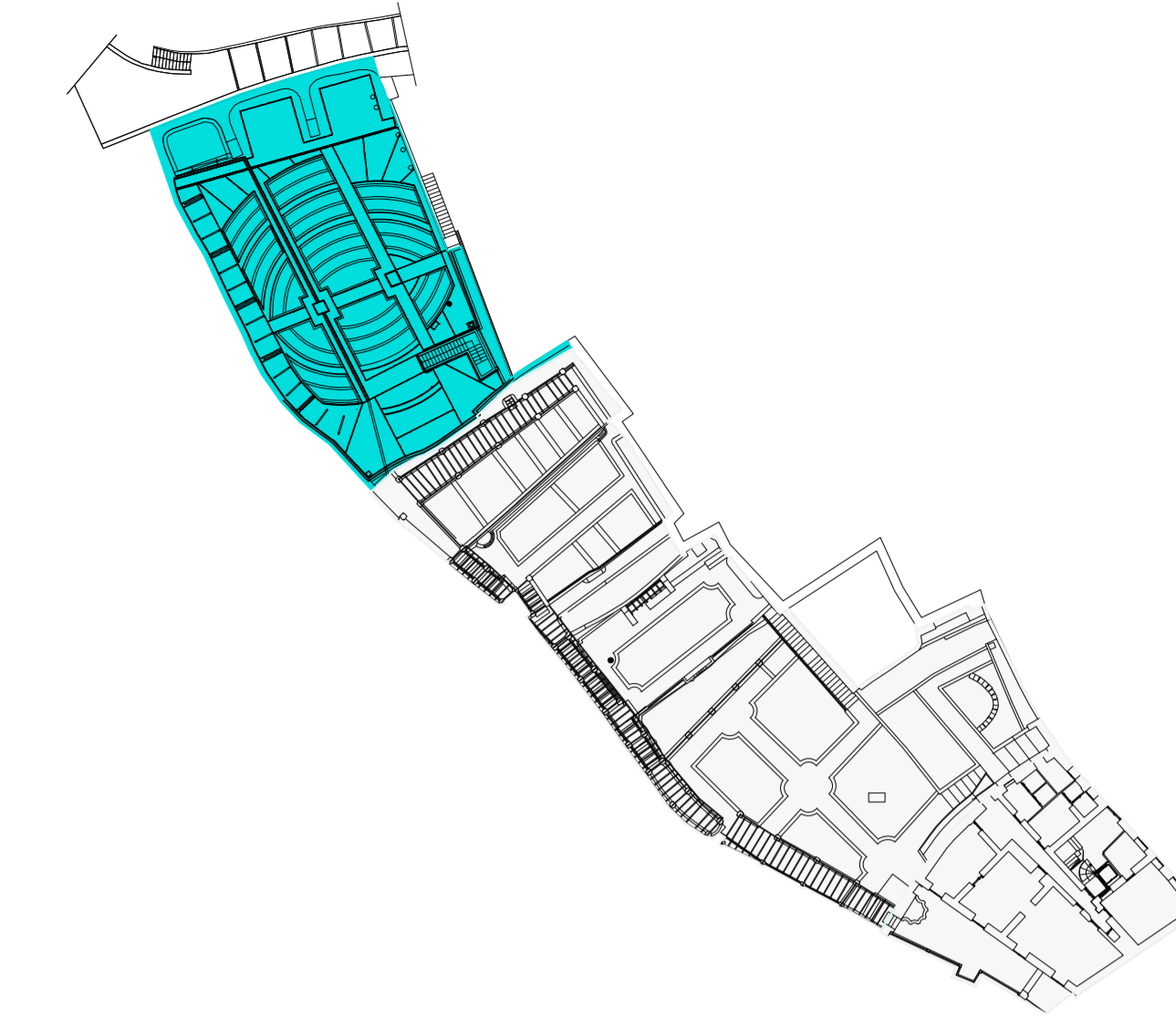
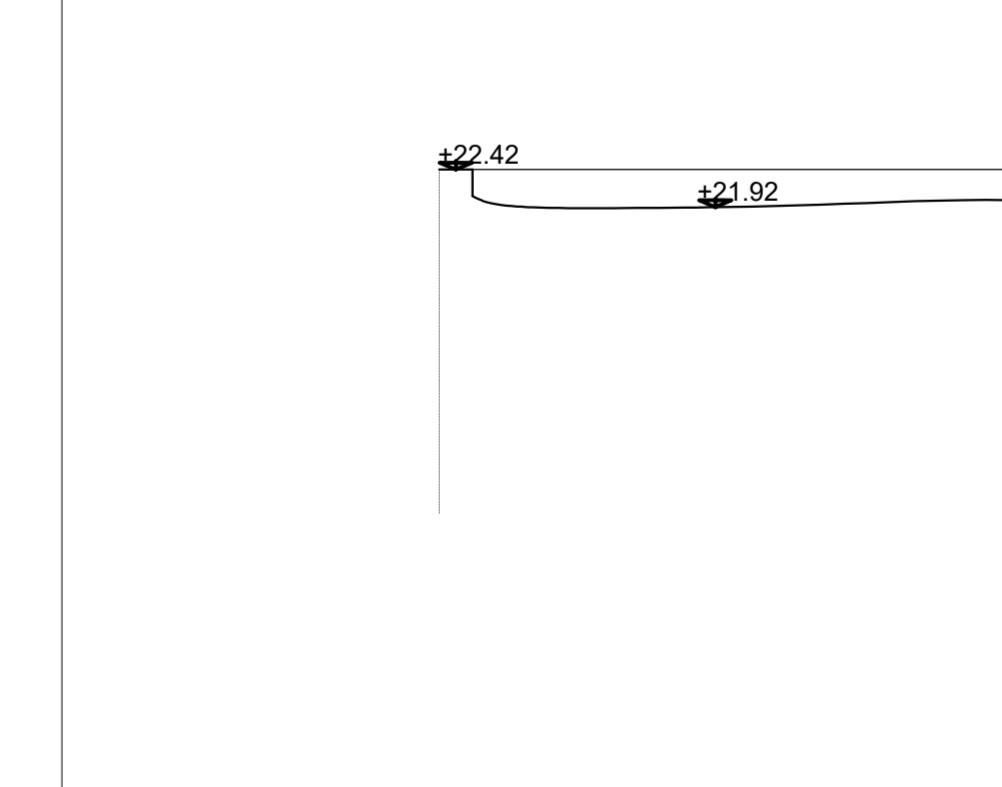

AMPLIAMENTO GIARDINO



Fondo per lo Sviluppo e la Coesione 2014-2020 - Piano Operativo "Cultura e Turismo"

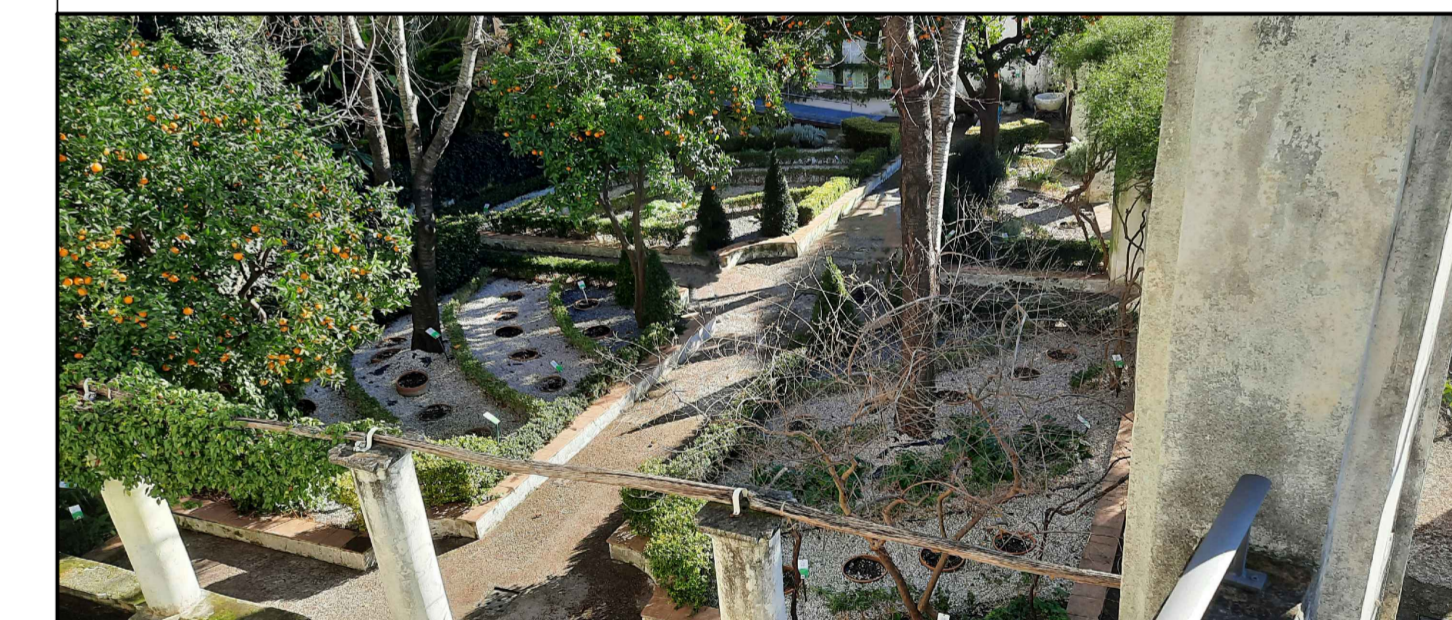

VALORIZZAZIONE, RIQUALIFICAZIONE E RICOMPOSIZIONE BOTANICA DEL GIARDINO DELLA MINERVA

PROGETTISTI		CONSULENTI	
Ing. Patrizia Desiderio	Progetto Verde Società Cooperativa s.r.l.	Ing. Domenico Fabricatore	
Mascheroni & Partners s.r.l.	Servizi geologici tecnici s.r.l. di Ferraro Leopoldo	Arch. Gianluca Giordano	
maccharoli & partners ingegneri impiantisti s.r.l.	Servizi Geologici Tecnici S.r.l.		
Arch. Carmelo Rizzo	Ing. Roberto Ciro Corrado, giovane professionista		

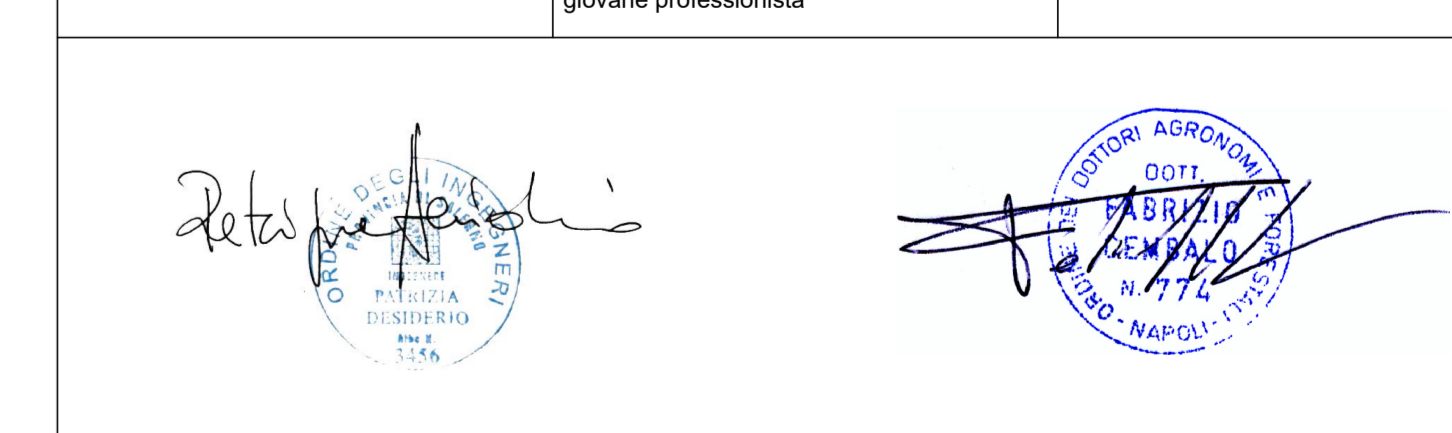

Fase	Titolo Elaborato	Codice Elaborato			
PDPE	Rilievo planialtimetrico e sezioni - Ampliamento Giardino	E.R.A.GRA.01.0			
Rev.	Descrizione	Data	Formato	Scala	Elaborato da/Controllato da/Approvato da
0	Prima emissione	25.07.2022	A1+	1/100	